



Manuel de l'utilisateur





[Configuration requise : Page 4](#)

[Installer : Page 5](#)

[Version Béta 7.004 : Page 6](#)

[Différences V6 / V7 : Page 7](#)

[Nouveautés V7 : Page 9](#)

[Créer une application d'automatisme : Page 12](#)

[Exécuter une application sur PC : Page 18](#)

[Ajouter un objet de supervision : Page 19](#)

[Exécuter une application sur automate : Page 21](#)

[Ouvrir un exemple de simulation de PO 3D : Page 22](#)

[Créer une application de simulation de PO 3D : Page 23](#)

[Communiquer vos appréciations : Page 31](#)

[Contacter IRAI : Page 32](#)

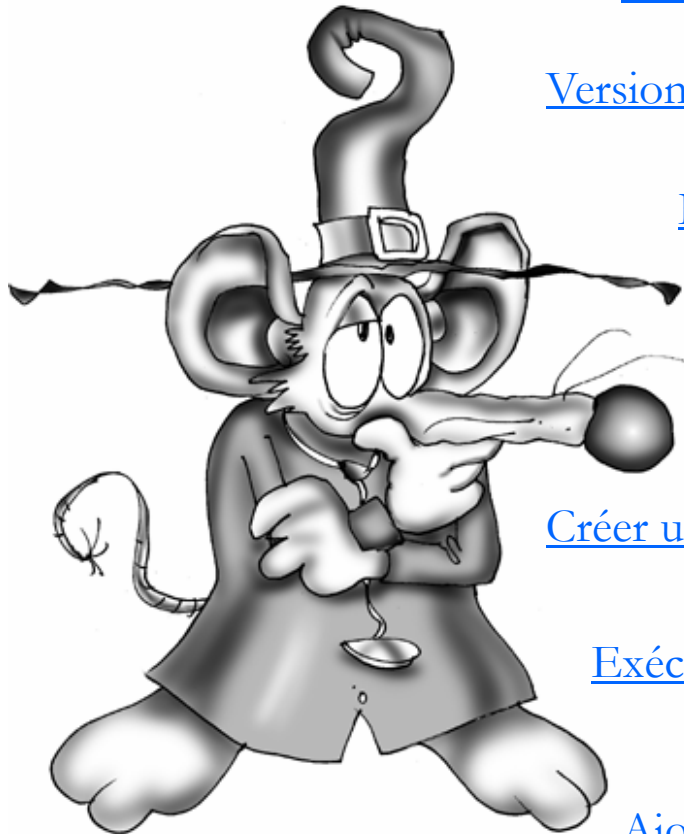

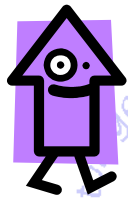

7

www.ira.com

Configuration require



- 95
- 98
- ME
- NT4
- 2000
- XP

32MO RAM

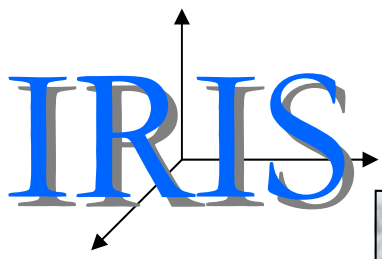

- 95
- 98
- ME
- ~~NT4~~
- 2000
- XP

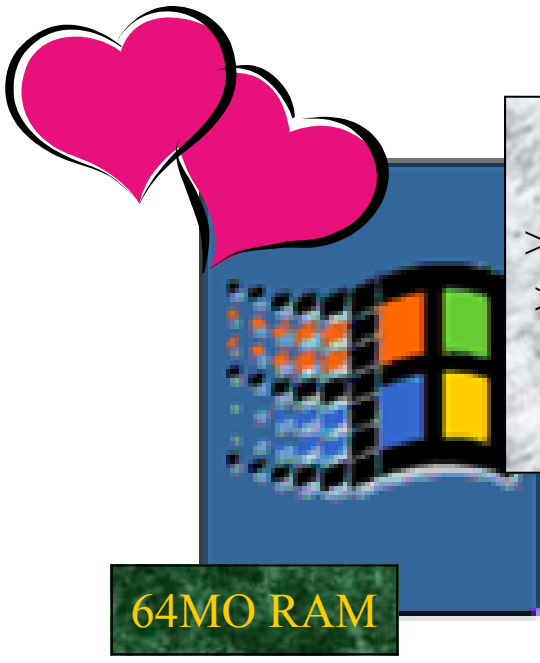

- ≥ 98 SE
- ≥ 2000

64MO RAM



7

www.irai.com

Installation

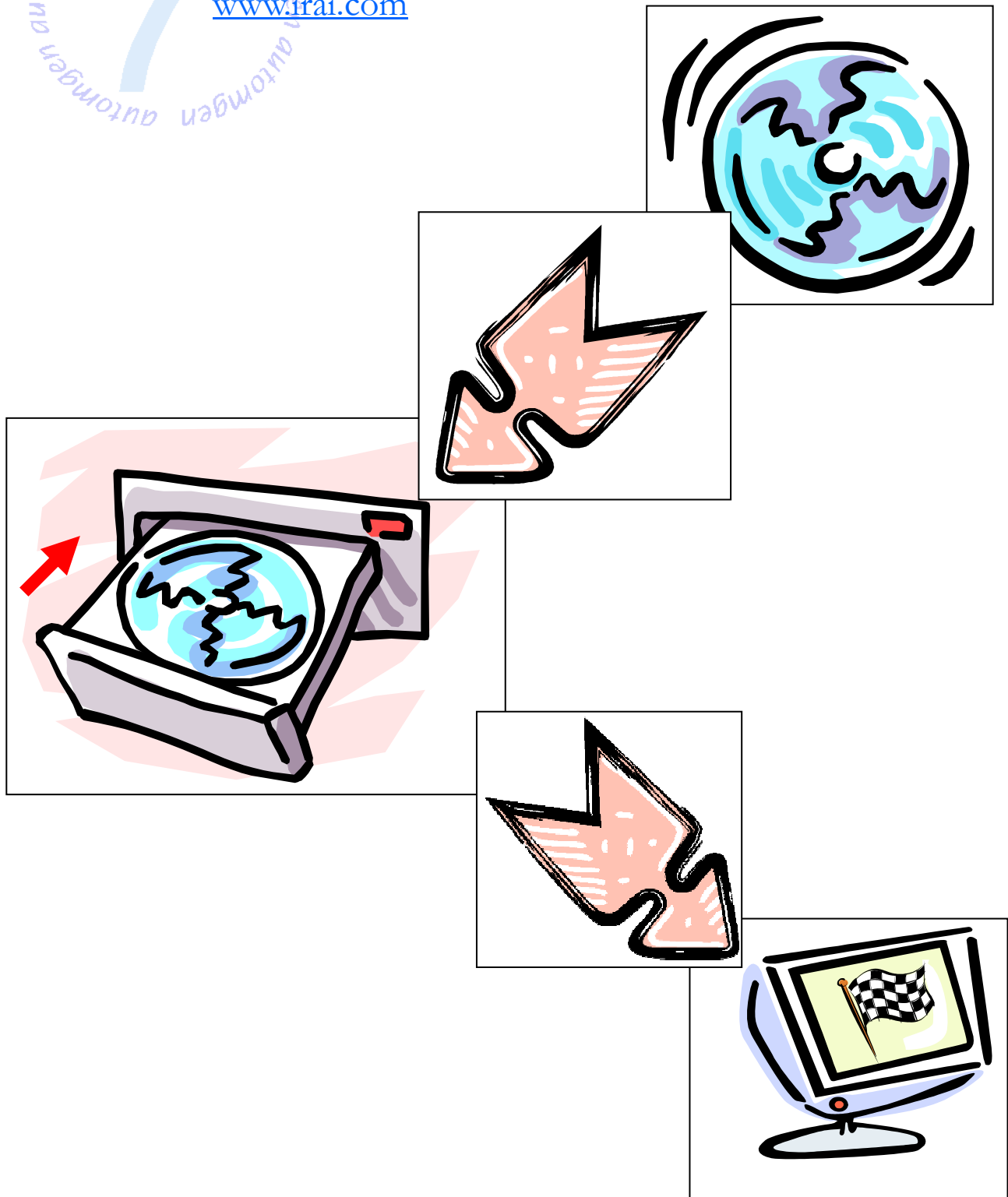

Si la procédure d'installation n'est pas lancée automatiquement, lancez l'exécutable « Setup.exe » qui se trouve à la racine sur le CD-ROM.



7

www.trafai.com

Version Béta 7.004

SCHNEIDER PL72	<input checked="" type="checkbox"/>
SCHNEIDER PL7 TSX 37 et 57	<input checked="" type="checkbox"/>
SIEMENS S7200 CPU 2xx	<input checked="" type="checkbox"/>
ABB	<input checked="" type="checkbox"/>
GE-FANUC / ALSPA	<input checked="" type="checkbox"/>
SCHNEIDER PL7 TSX 07	<input checked="" type="checkbox"/>
SIEMENS STEP5	<input checked="" type="checkbox"/>
KLOCNER-MOELLER PS3-PS4	<input checked="" type="checkbox"/>
CROUZET RPX	<input checked="" type="checkbox"/>
SCHNEIDER PL71	<input checked="" type="checkbox"/>
OMRON	<input checked="" type="checkbox"/>
FESTO	<input checked="" type="checkbox"/>
APRIL BP	<input checked="" type="checkbox"/>
APRIL SMC	<input checked="" type="checkbox"/>
SIEMENS S7300 CPU 3xx	<input checked="" type="checkbox"/>
ALSPA C50/C100	<input checked="" type="checkbox"/>
8051 TSX 17-20 + TZ51 ou TSX 47-20+ 20Z51	<input checked="" type="checkbox"/>
Autres	<input type="checkbox"/>

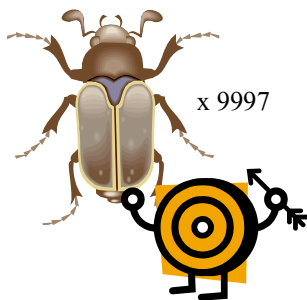
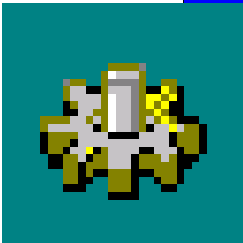

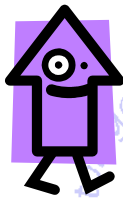

www.trafai.com

Différences V6 / V7 (1/2)

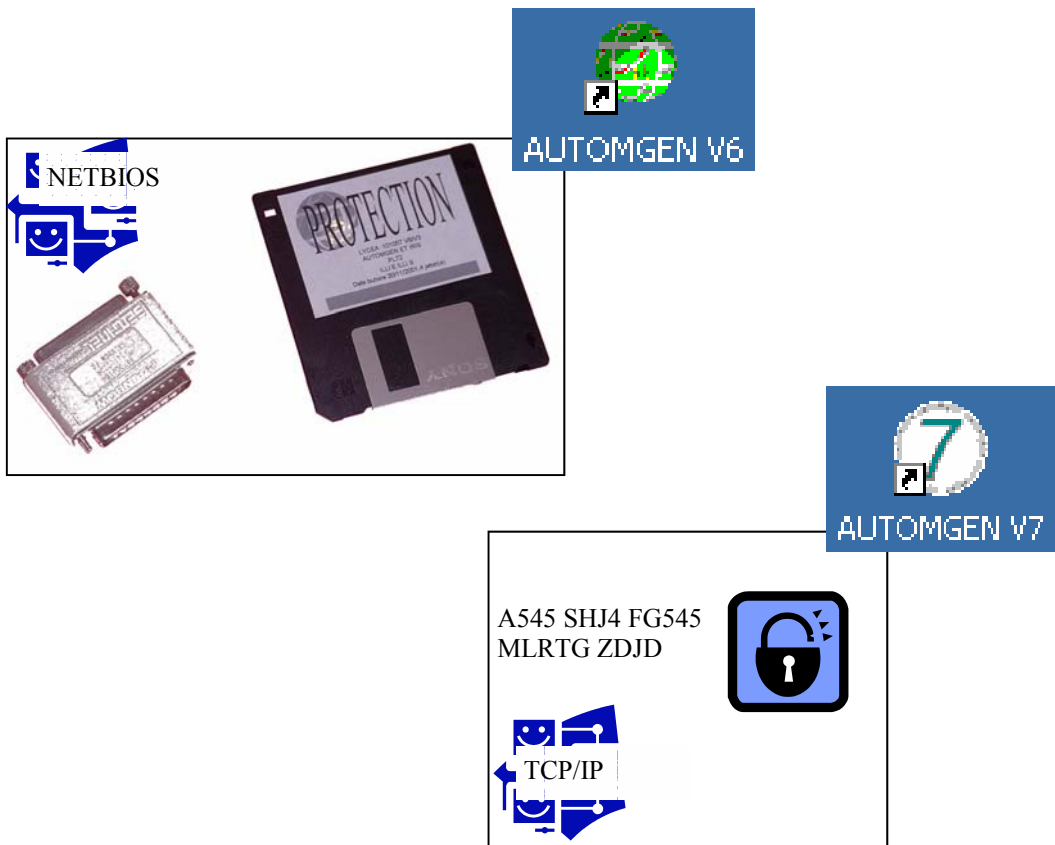
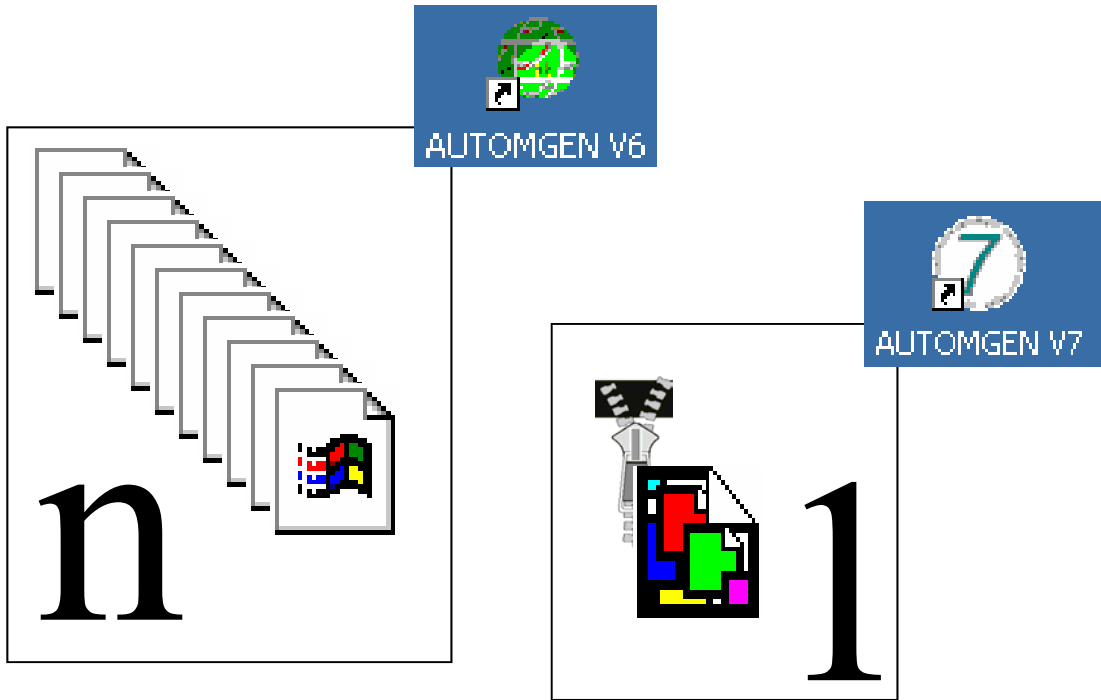
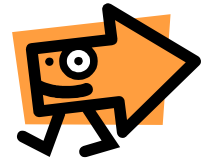



www.traai.com

Différences V6 / V7 (2/2)

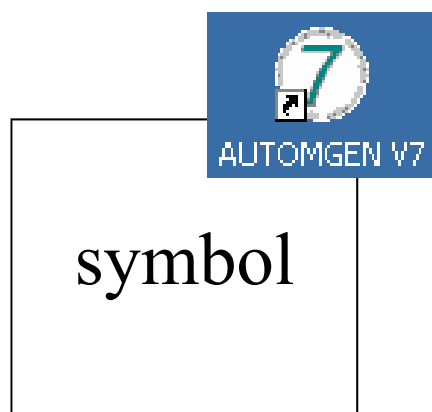
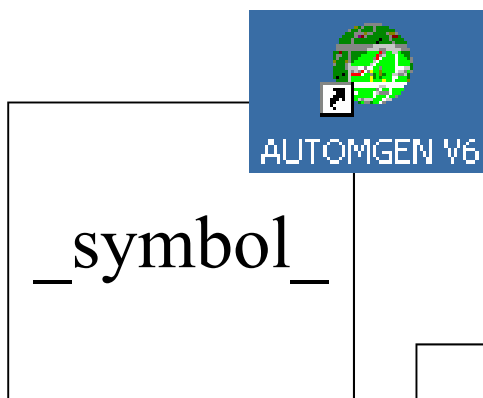
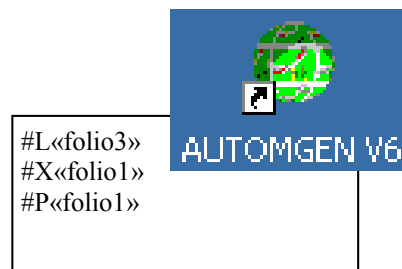
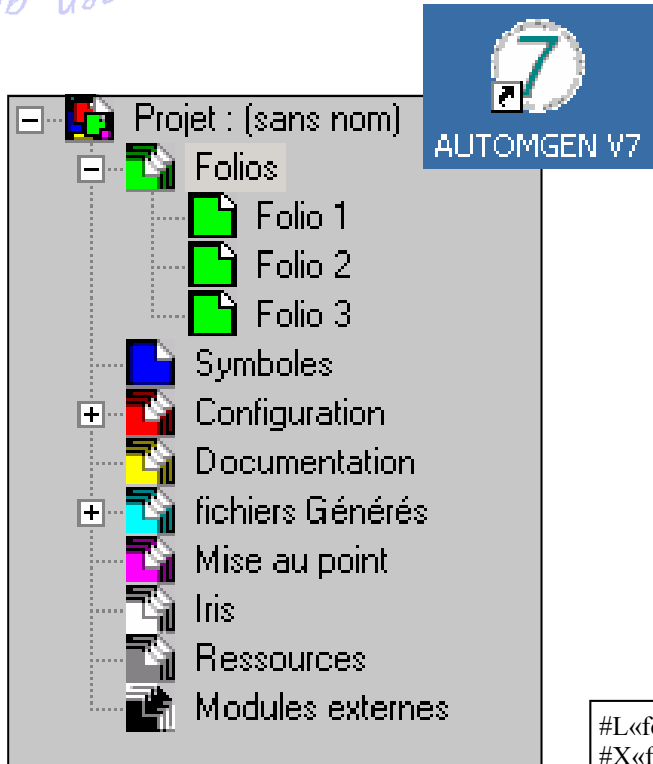
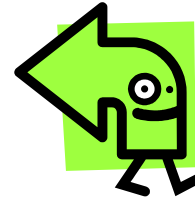

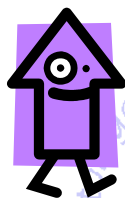

Nouveautés V7 (1/3)

www.iri.com

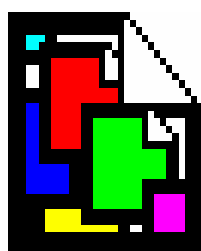
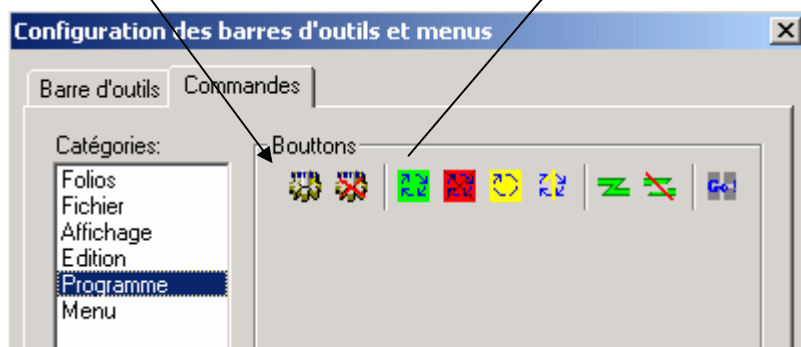

EXE

IRIS

 Ajouter un pupitre iris 3D

SOLIWORKS
SOLIDCONCEPTER
3DSTUDIO
FICHIERS VRML

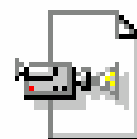
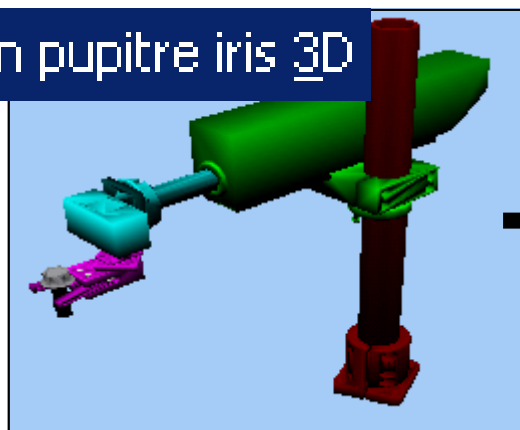

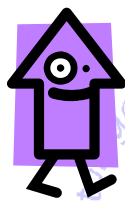

7

www.irai.com

Nouveautés V7 (2/3)

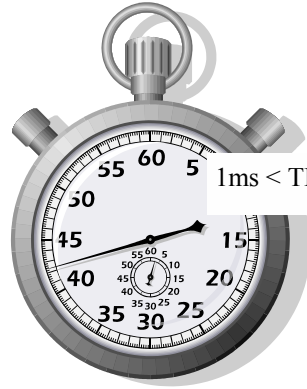
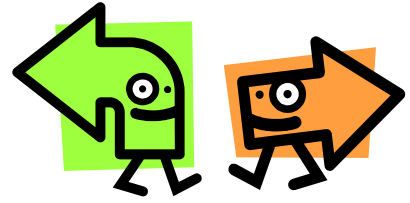

1ms < TEMPO < 27d

```
decy. | (m200 > 4 + m200 <
```

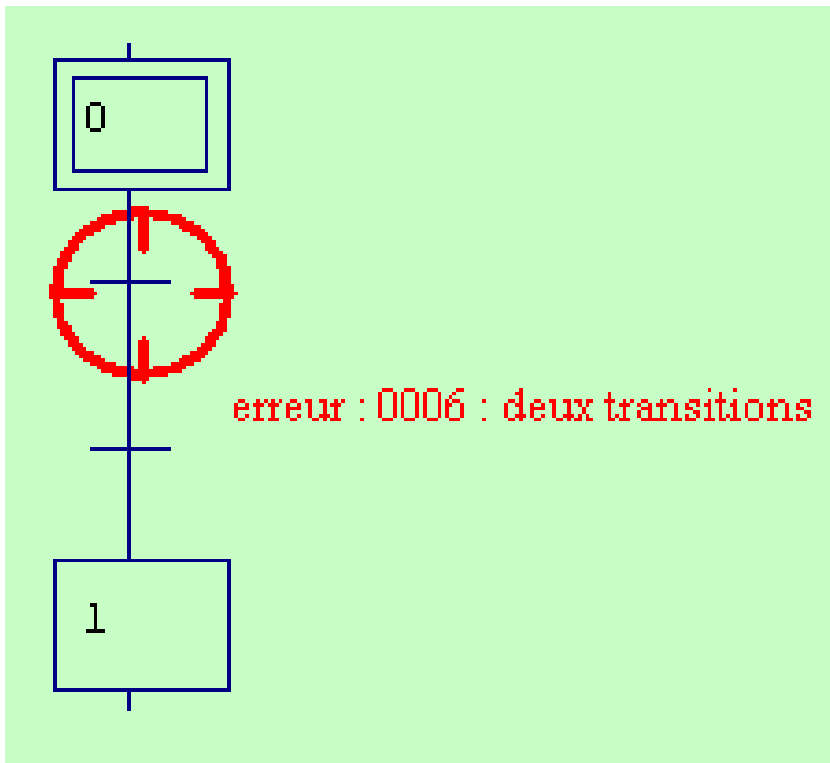
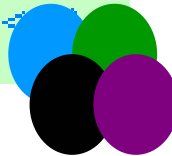

Assistant objet IRIS 2D

- Objets prédéfinis
 - Eléments statiques
 - Texte à poser sur un
 - Boutons poussoirs
 - Arrêt d'urgence
 - Mise en marche, mise
 - Mise à l'arrêt, mise à C
 - Bouton rond noir
 - Bouton rond rouge
 - Bouton rond vert
 - Bouton rond bleu
 - Alfichieurs
 - Interrupteurs
 - Pupitres
 - Voyants
- Mes objets
- Objets de base

Paramètres

Action(s) associée(s) à l'état bp appu

Action(s) associée(s) à l'état bp relac

Aperçu

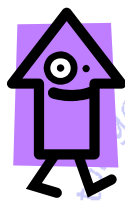

Nouveautés V7 (3/3)

www.irai.com

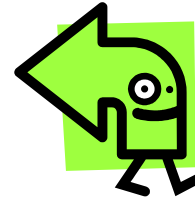

Elements	Valeurs
+ Configuration matérielle	
- Configuration logicielle	
..... Capacité mémoire en Ko	8
..... Compteur rapide	C
..... Prédiposition compteur rapide	100
..... Modification compteur rapide	YES
..... Entrées lues dans la tâche rapide	NO
..... Sorties écrites dans la tâche rapide	NO
..... Nombre de mots communs	4
..... Mode de communication de la prise cons...	ASCII
..... Vite... prise console RS485	9600
..... Nur... ve UNITELWAY	1
..... s de stop de la prise	2

Connecter et télécharger

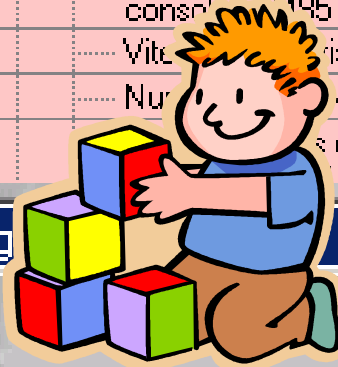

Ne plus ouvrir cette boîte de dialogue, toujours utiliser l'option choisie



Paramètres de communication

Définir par défaut

Go!

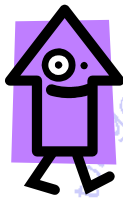

Créer une application d'automatisme 1/6

www.ira.com

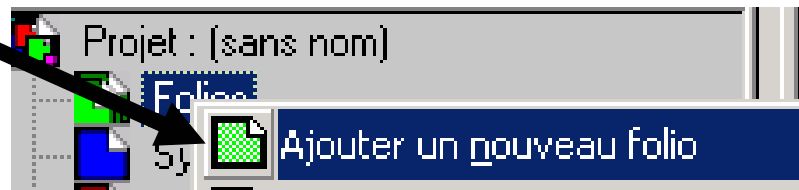
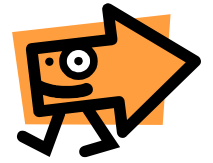

Créer un nouveau folio

Nom (un nom générique), laissez le nom par défaut ou entrez un nom significatif.

Taille (les dimensions de la surface du folio). Par défaut, XXL permet de créer de très grands folios (recommandé). Pour créer un Gemma choisissez "Gemma".

Commentaires (par exemple les dernières modification, l'auteur, etc ...).

Créé le 13/9/2001.
Modifié le 13/9/2001.

Définissez les caractéristiques du nouveau folio, sa taille, son nom, plus d'éventuels commentaires. Tout ceci pourra être modifié par la suite.



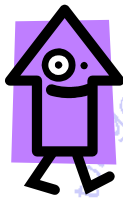

Créer une application d'automatisme 2/6

www.irai.com

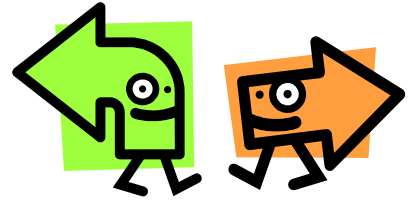

The screenshot displays a software interface for creating automation applications. On the left, a vertical palette contains three main categories: 'étape initiale' (initial step), 'étape normale' (normal step), and 'transition'. Below these is a 'Plus ...' menu item and an 'Edition ...' option. On the right, a toolbar includes 'Boîte de code' (code box), 'lien' (link), and 'assistant'. The 'assistant' button is highlighted in a dark blue bar at the bottom of the toolbar. Three mouse icons with arrows indicate interactions: one pointing to a red box in the workspace, one pointing to the 'Plus ...' menu item, and one pointing to the 'assistant' button.

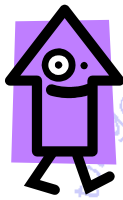

Créer une application d'automatisme 3/6

www.iraï.com

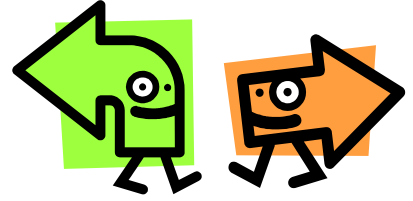

Assistant

Grafcet

en ligne étape initiale rebloqué rectangles d'actions étapes

divergence en Ou branches première

divergence en Et interval

OK Annuler

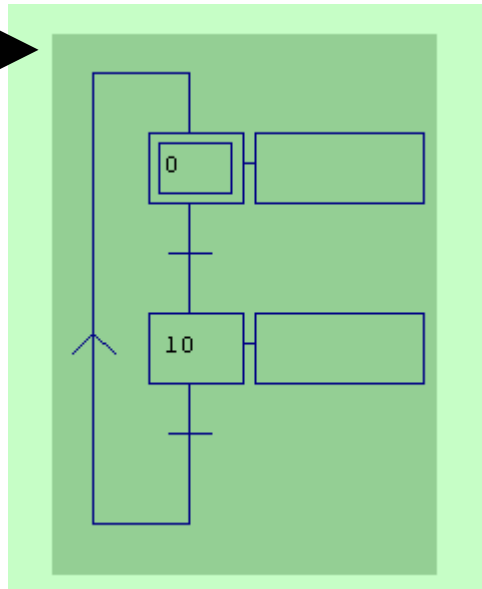



Créer une application d'automatisme 4/6

www.trafi.com

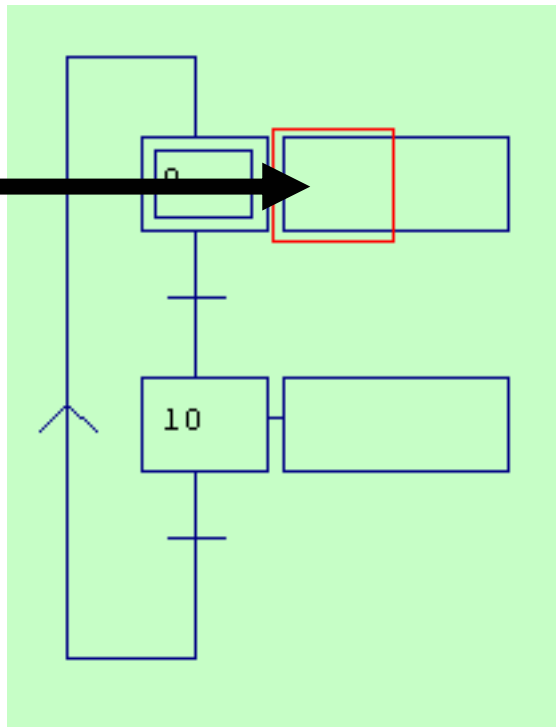
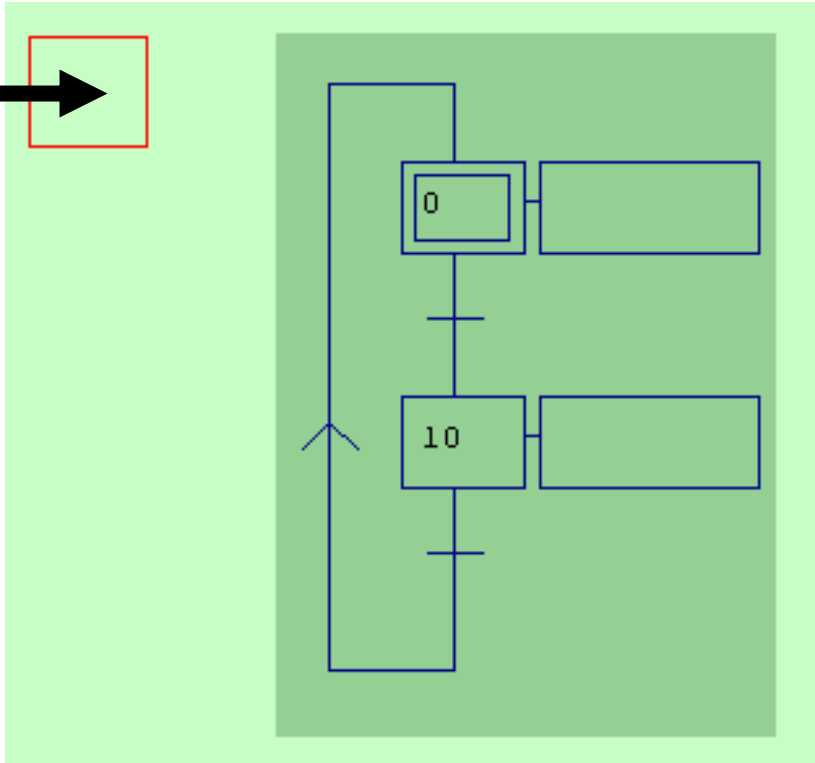
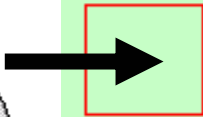
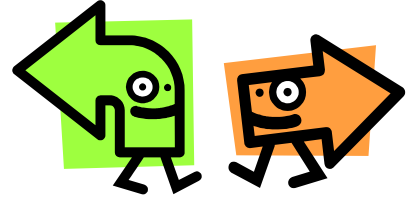



Créer une application d'automatisme 5/6

www.irai.com

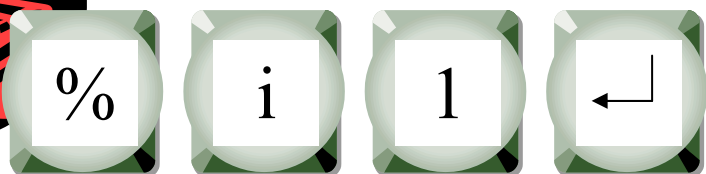
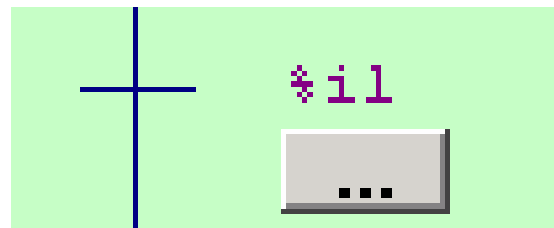
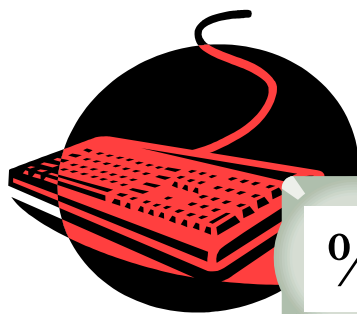
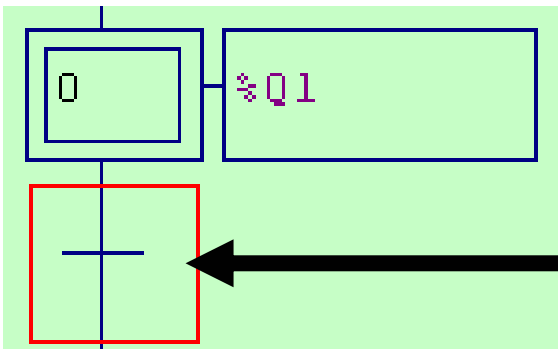
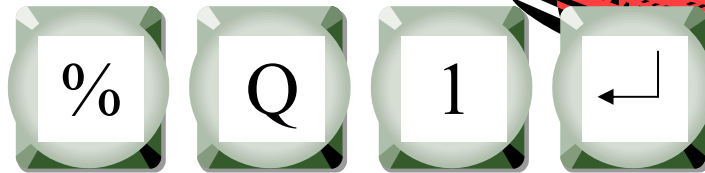
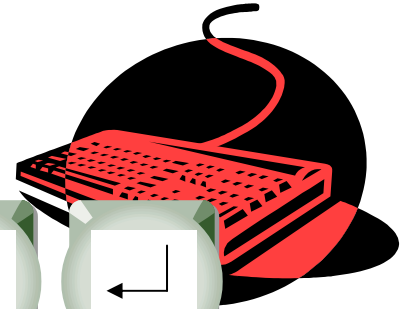
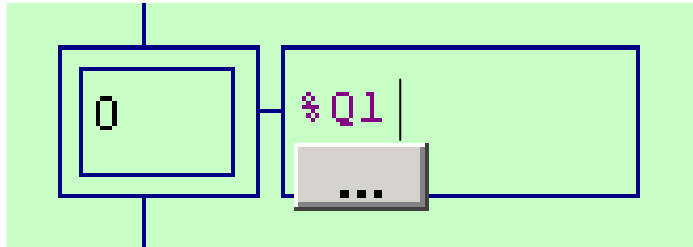
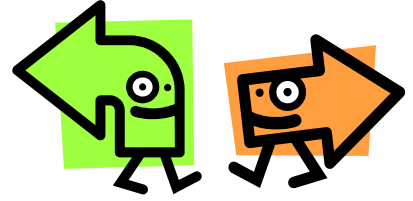



Créer une application d'automatisme 6/6

www.trafi.com

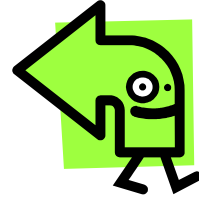

```
10  %Q2|  
...
```

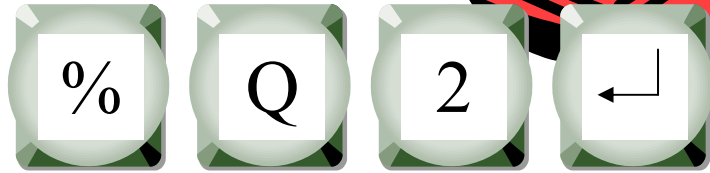
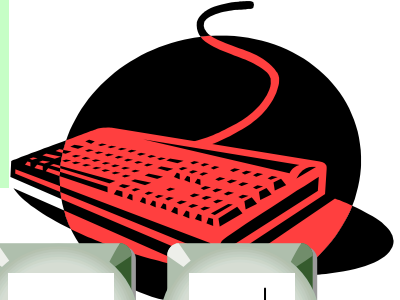

```
+  %i2|  
...
```

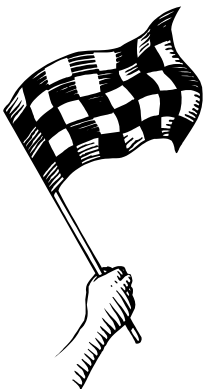
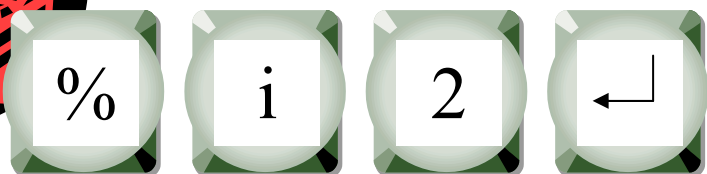
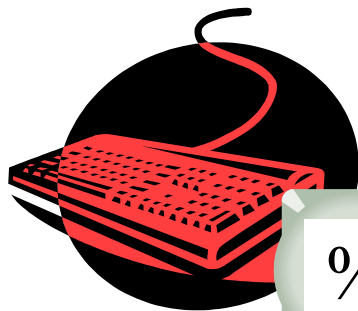

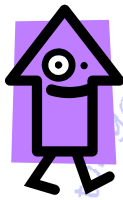



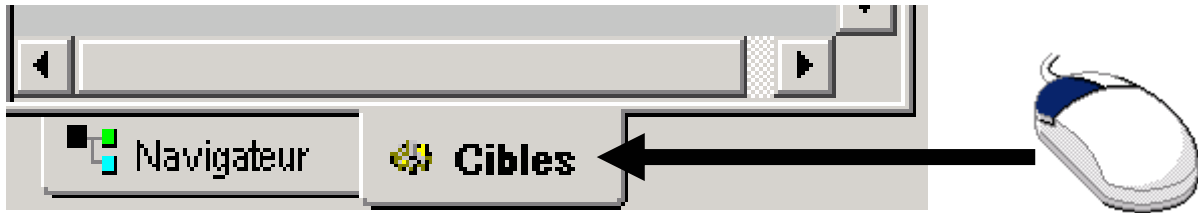

7

www.tra.com

Exécuter une application sur PC



Actif	Nom	Version
	Exécuteur PC	7.000
	PL7 (Tsx 37 & Ts...	7.000
	PL72	7.000

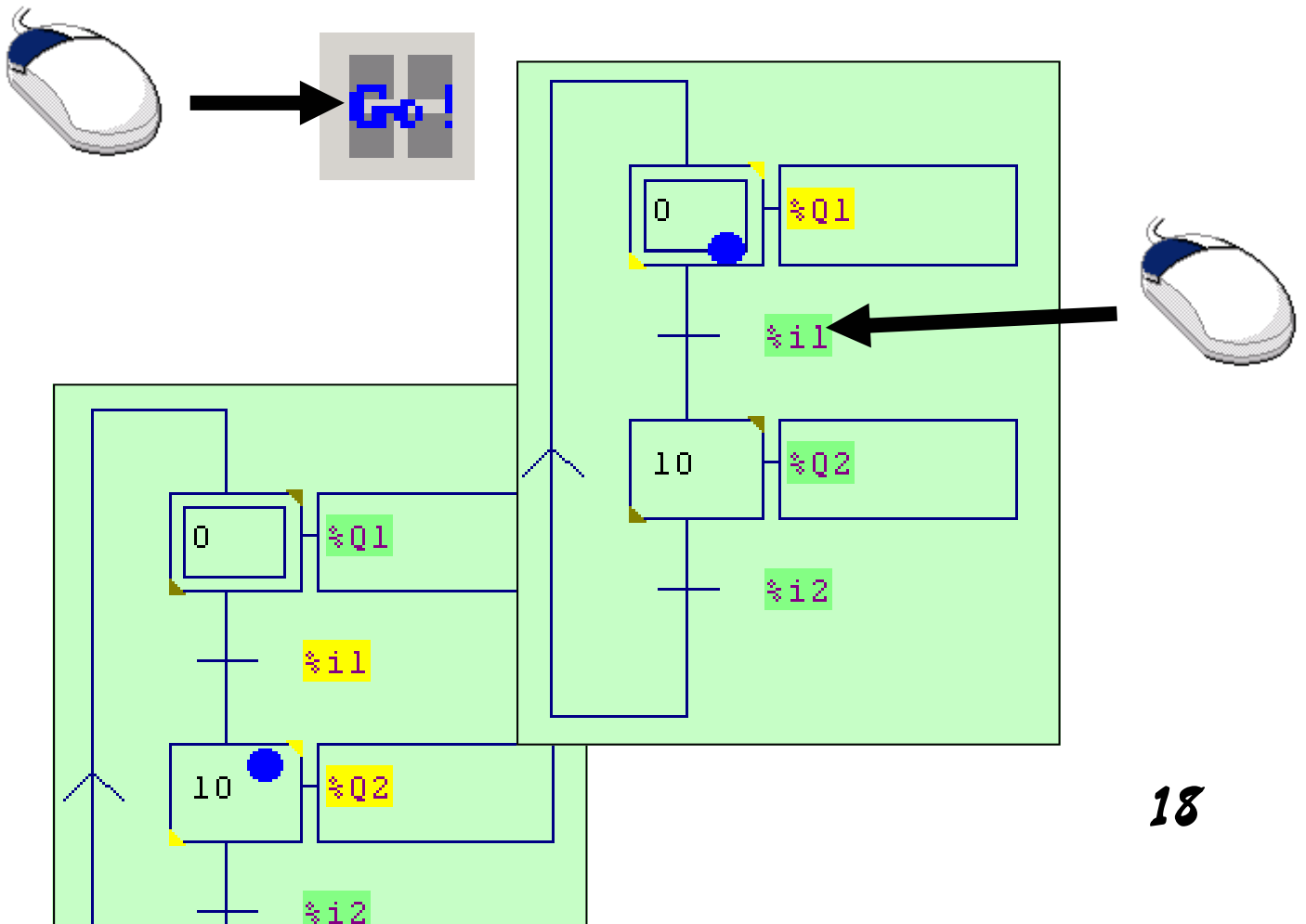

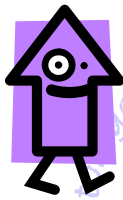

Ajouter un objet de supervision 1/2

www.irai.com

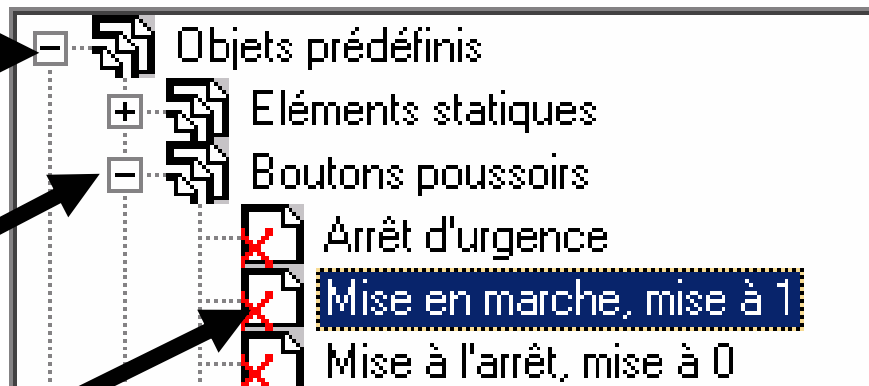
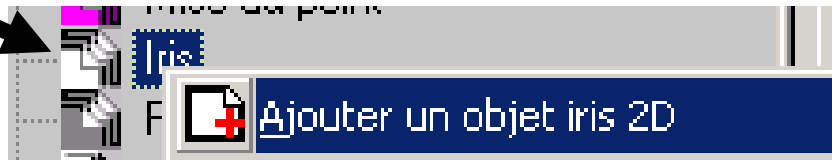
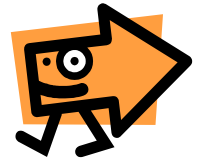

Paramètres	Valeurs
Action(s) associée(s) à l'état bp appuyé	%I=1
Action(s) associée(s) à l'état bp relaché	00=0

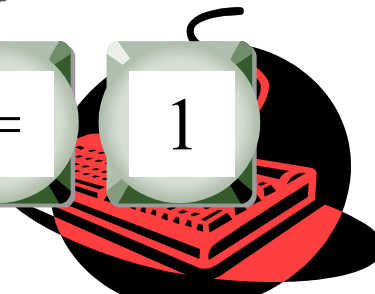
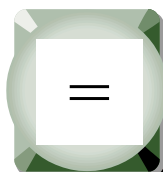
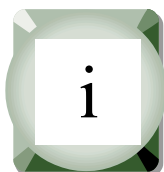

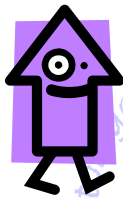

Ajouter un objet de supervision 2/2

www.iraï.com

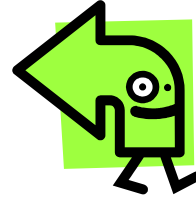

Paramètres	Valeurs
Action(s) associée(s) à l'état bp appuyé	%I1=1
Action(s) associée(s) à l'état bp relaché	<input type="text" value="%I1=0"/>

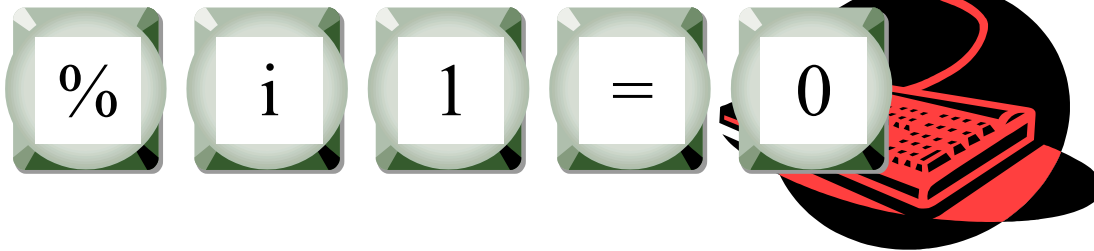
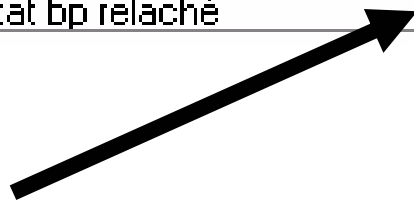



Exécuter une application sur automate

www.ிரai.com

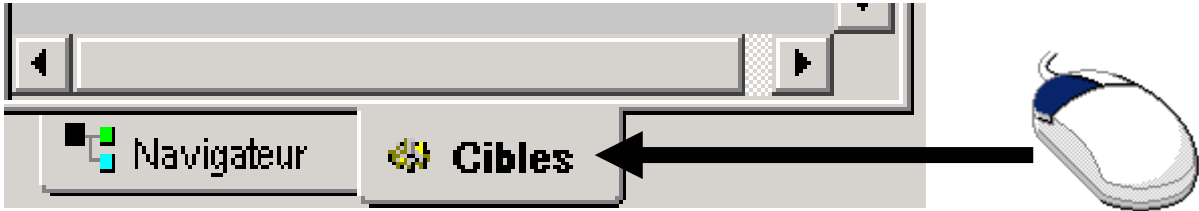

Actif	Nom	Version
	Exécuteur PC	7.000
	PL7 (Tsx 37 & Ts...	7.000
	PL72	7.000

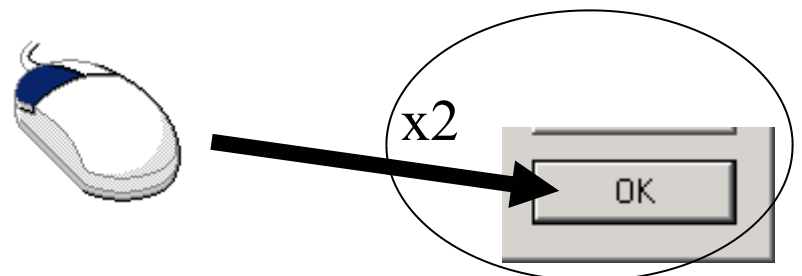
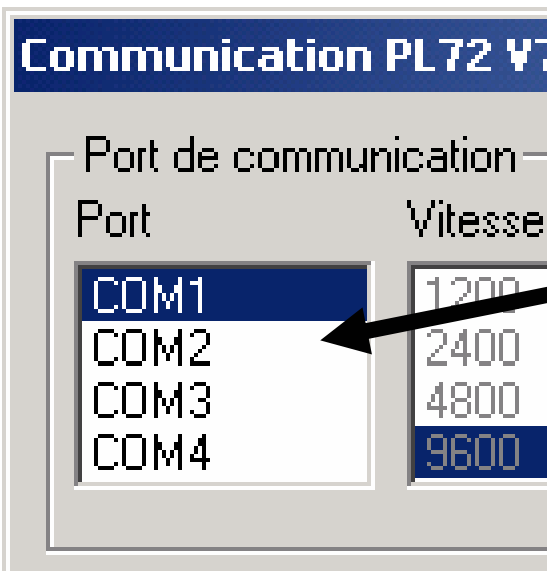
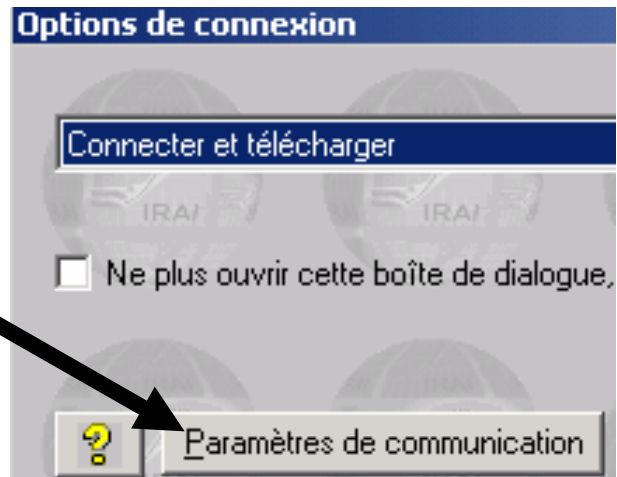

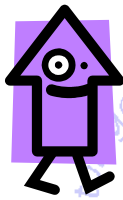

Ouvrir un exemple de simulation de PO 3D

www.irai.com

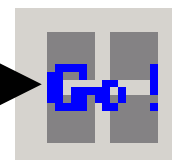
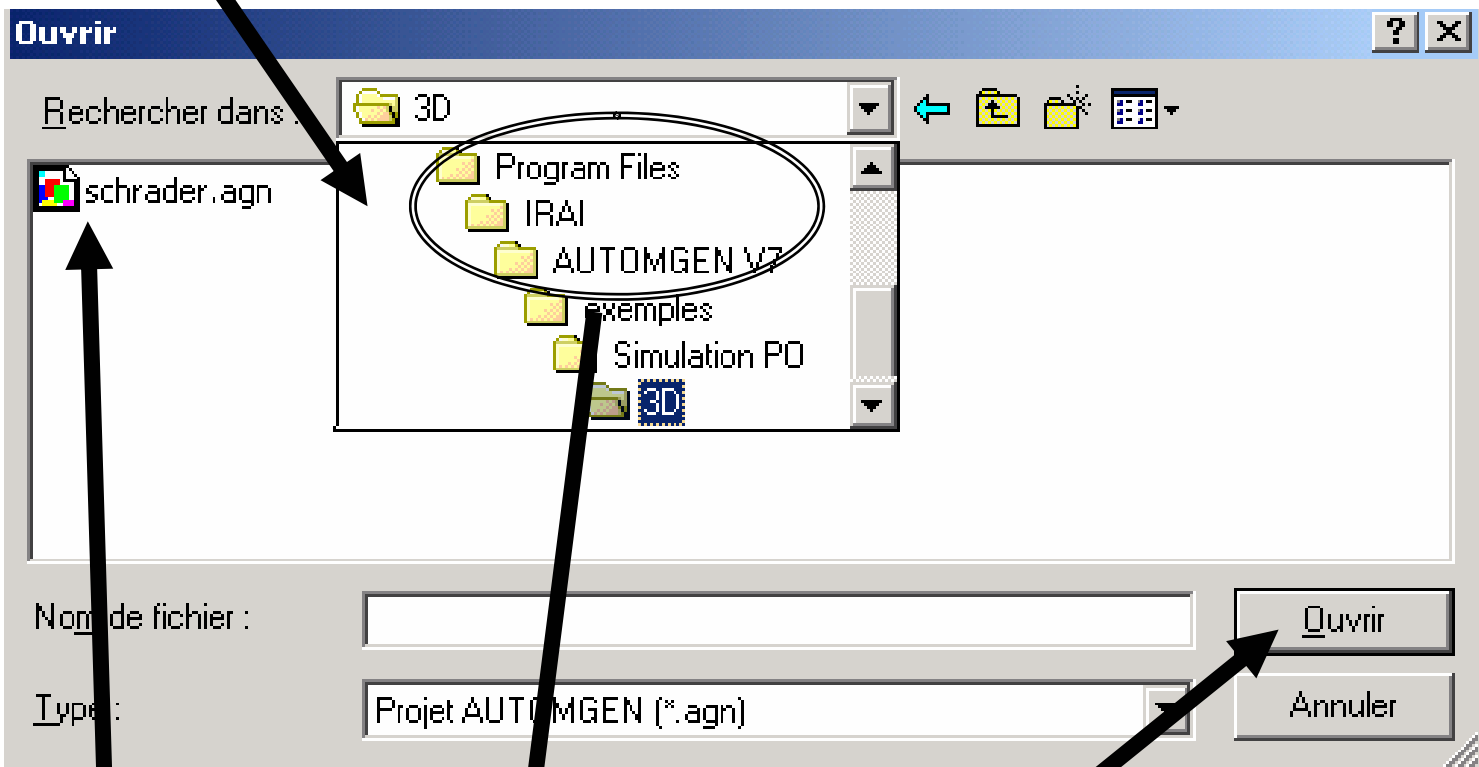



Créer une application de simulation de PO 3D

www.irai.com

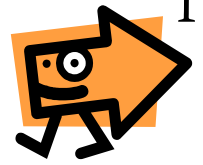

1/8



SOLIDWOKS
SOLIDCONCEPTER



3DSTUDIO
AMAPI3D
<http://delphi3d.free.fr>

CROSSROADS

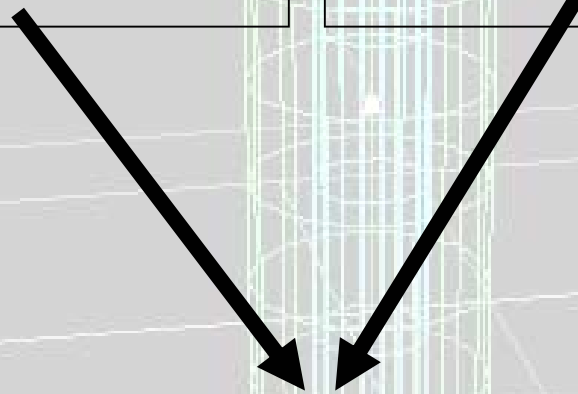

n x  .3DS



Un fichier .3DS par objet 3D
devant être déplacé séparément.

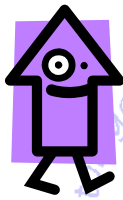

Créer une application de simulation de PO 3D

www.irai.com

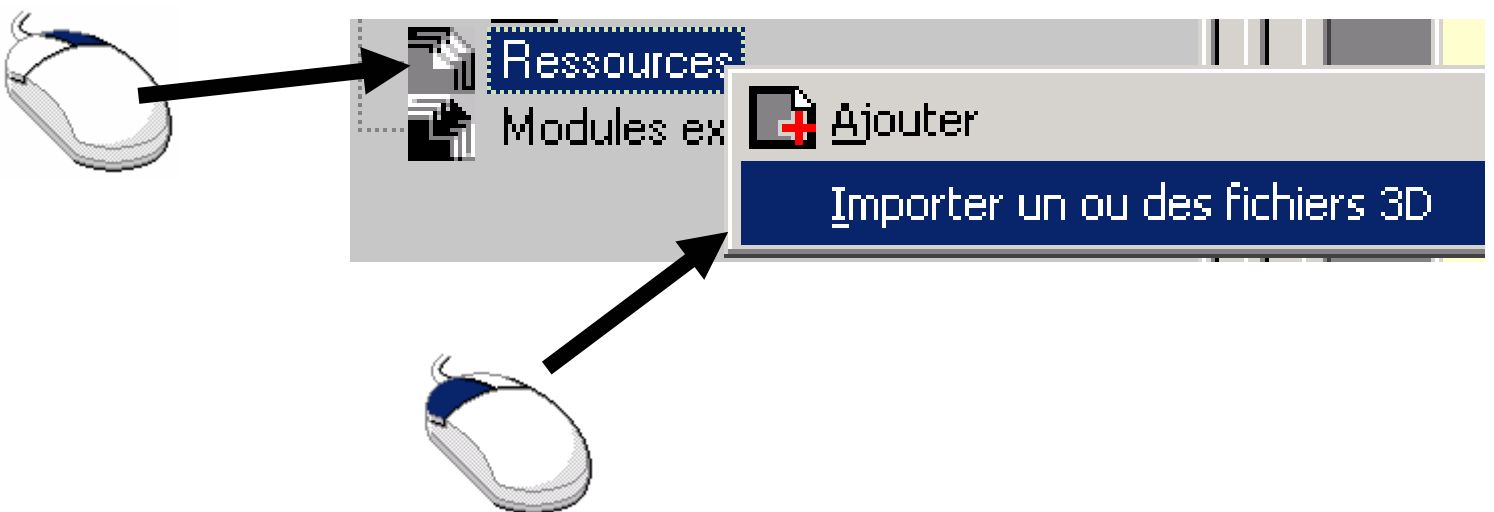
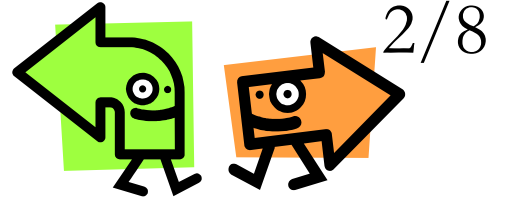

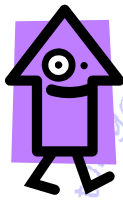

Créer une application de simulation de PO 3D

www.irai.com

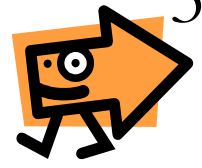
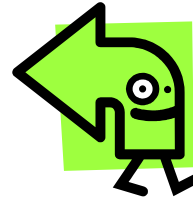

3/8

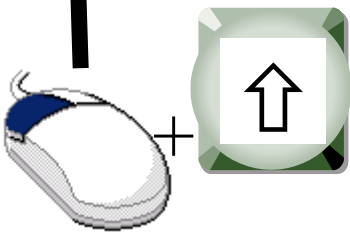
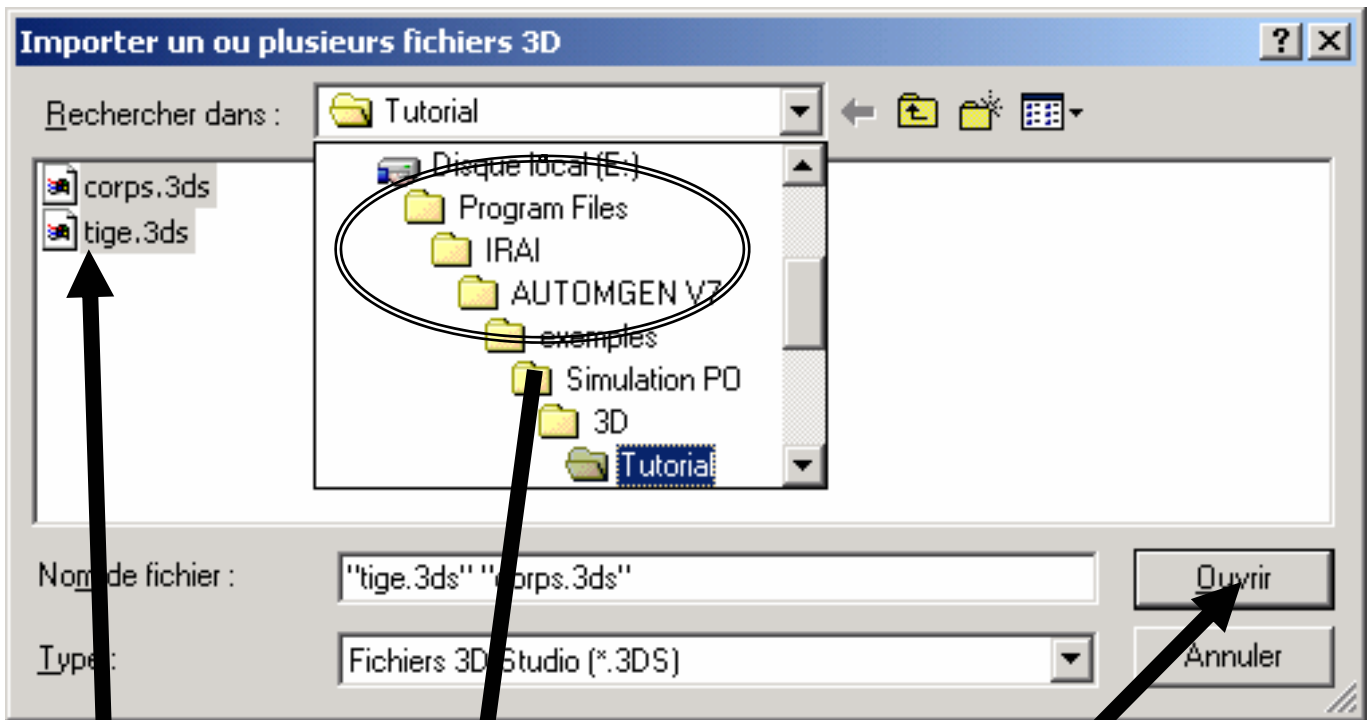

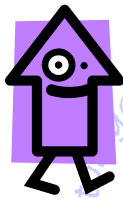

Créer une application de simulation de PO 3D

www.iri.com

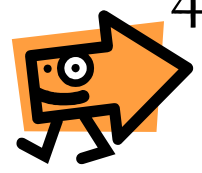
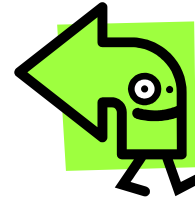

4/8

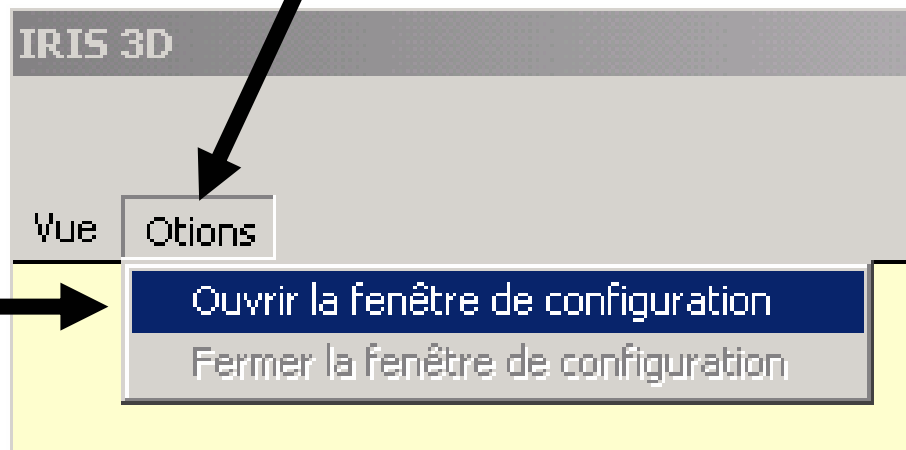
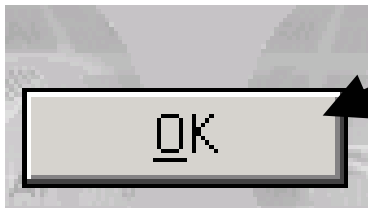
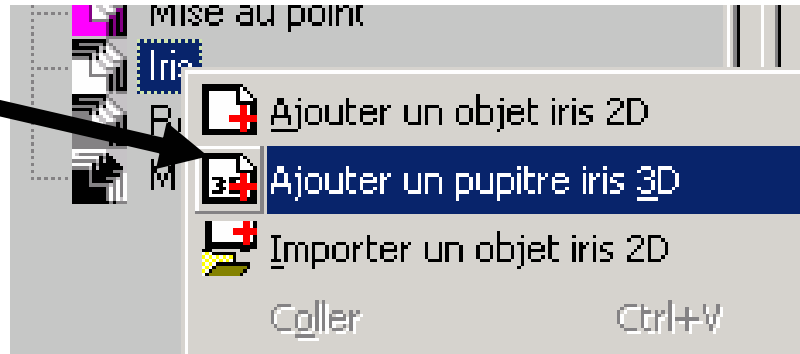



Créer une application de simulation de PO 3D

www.irai.com

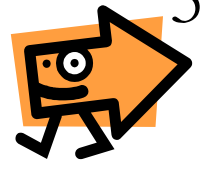
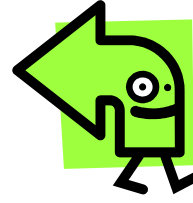

5/8

Objets 3D ...

- corps : 0
- tige : 1

Rafraîchir Centrer sur l'objet sélectionné

 Ajouter Ajouter tout



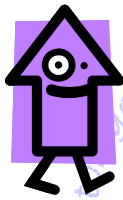

Créer une application de simulation de PO 3D

www.irai.com

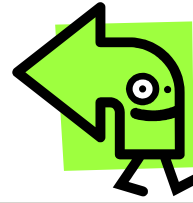

6/8

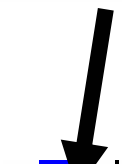
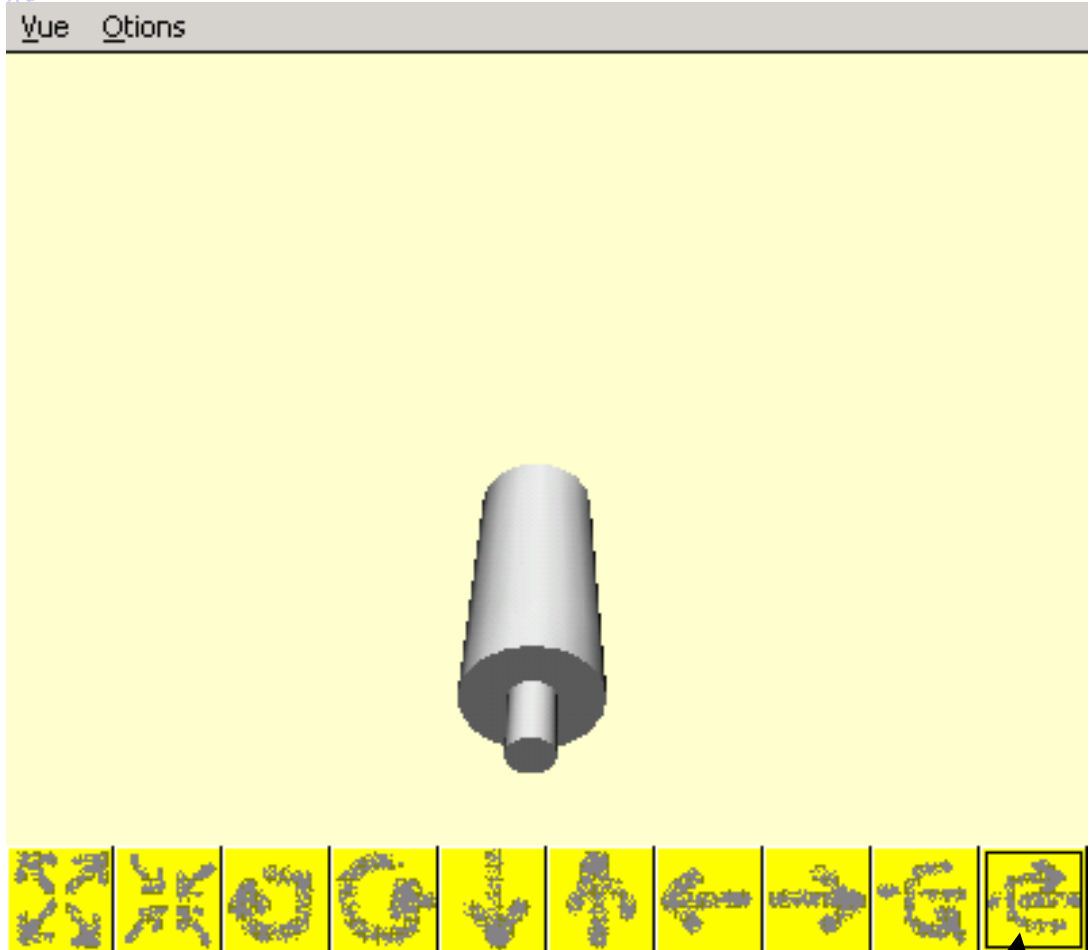

Ajouter une translation

Ajouter une rotation



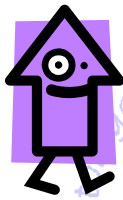

Créer une application de simulation de PO 3D

www.irai.com

7/8

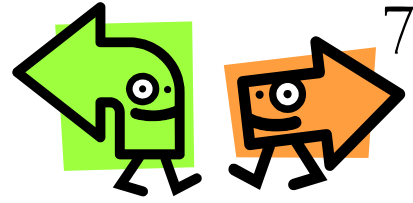

Translation

tige : 1

Position

Pas de pilotage
 Pilotage bistable
 Pilotage monostable
 Pilotage numérique

Mini
 Maxi
 Temps pour la course en ms

Axe

X
 Y
 Z

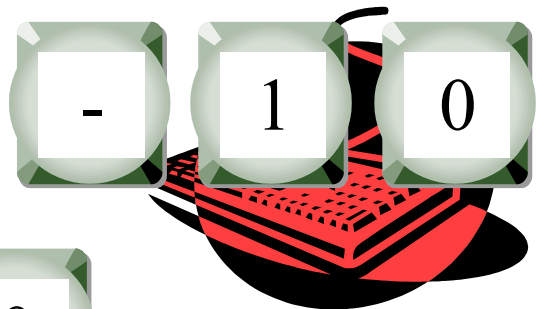
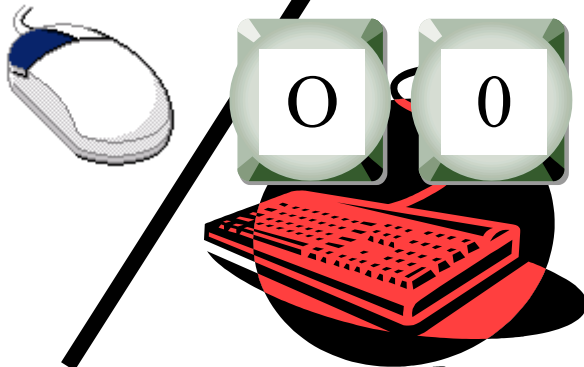

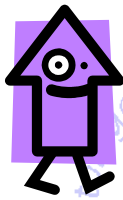

Créer une application de simulation de PO 3D

8/8

www.ira.com

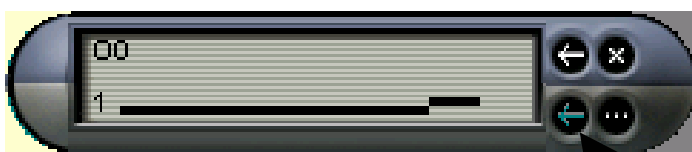
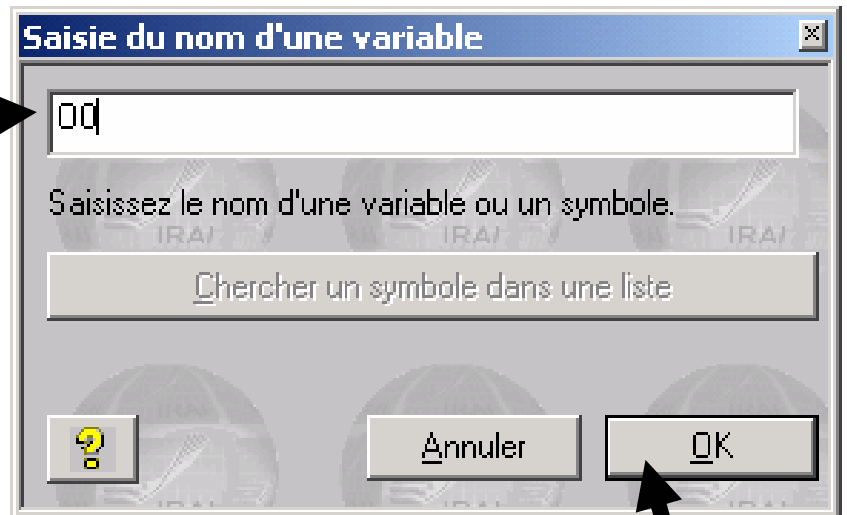
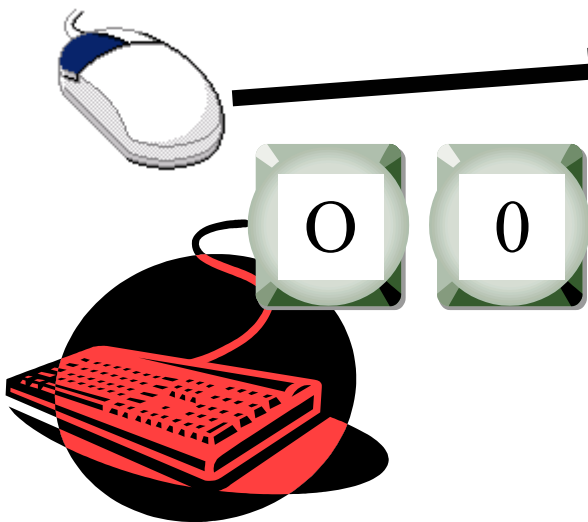
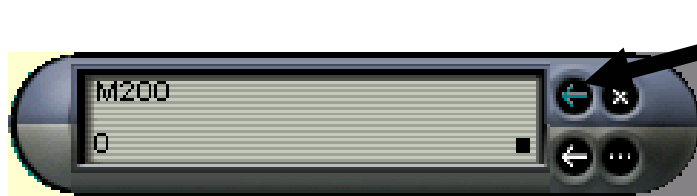
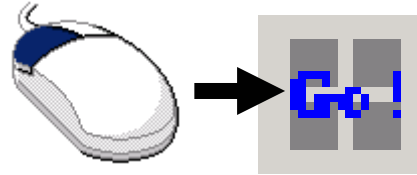
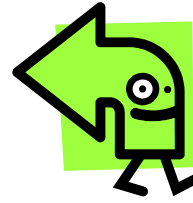



7

www.trafi.com

Communiquer vos appréciations

Editeur

 0 1 2

Environnement

 0 1 2

PO 3D

 0 1 2

Mini notice

 0 1 2

Appréciation générale

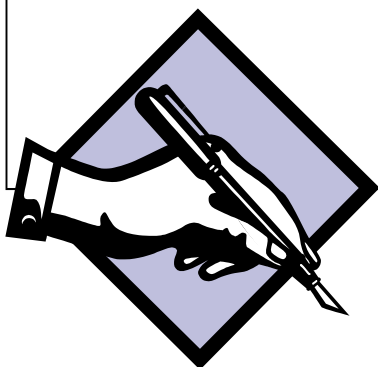
 0 1 2



7

www.iraï.com

Contacter IRAI



04 66 54 91 30

04 66 54 91 33

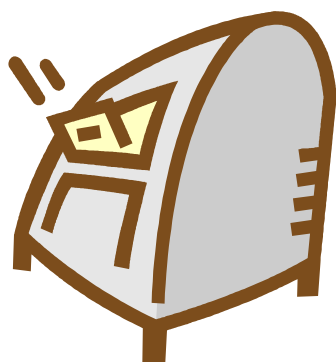

IRAI
BP 14
17 avenue du 19 mars 1962
30110 LA GRAND COMBE
FRANCE

contact@iraï.com

